

# INSTALLATION INSTRUCTIONS FOR STEEL FRAME ONTO STEEL STUD WALL

## Tools & Materials You Will Need:

• 1" Thick Wood Spreader	• Long Carpenter's Level
• Carpenter's Square	• Flathead Screwdriver
• Hammer	• Shims
• (1) box #6 x 3/8" (min.) Steel Sheet Metal or Self-Tapping Screws	



**IMPORTANT!** If a threshold is to be installed, **DO NOT install until AFTER the steel frame is fully assembled and secured in opening.**



**JOB SITE STORAGE:** Store frame off the ground on wood runners or skids. **DO NOT STORE** directly on the ground. Cover frames with tarpaulin or plastic, ensuring that adequate ventilation is provided to eliminate moisture condensation.

When frames are fully grouted and/or when plaster or mortar contain "anti-freeze" agents, the inside of the frames should be coated with a bituminous, water-resistant paint by the installation contractor.

**REMEMBER: ALWAYS USE THE APPROPRIATE PERSONAL PROTECTIVE EQUIPMENT.**



Homes built before 1978 may contain lead paint. All replacement installations must comply with the U.S. EPA's Lead-Based Paint Renovation, Repair, and Painting Program (RRP Rule). Read more about the RRP Rule and lead-safe work practices, on the U.S. EPA's website at: [www.epa.gov/lead](http://www.epa.gov/lead)

## 1 PREPARE ROUGH OPENING

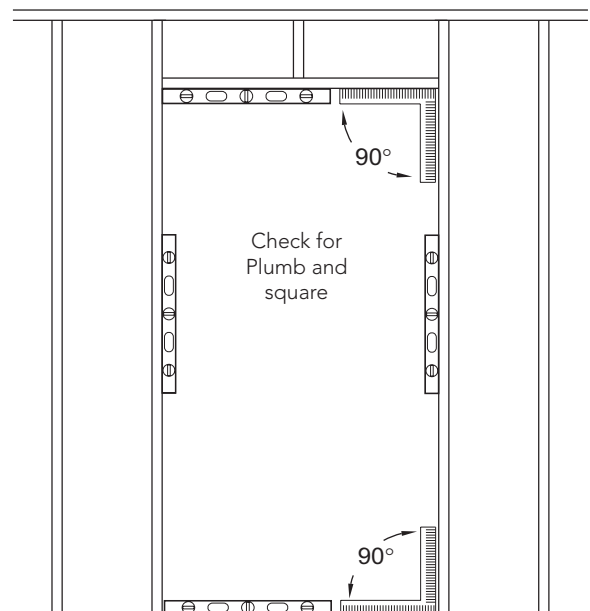
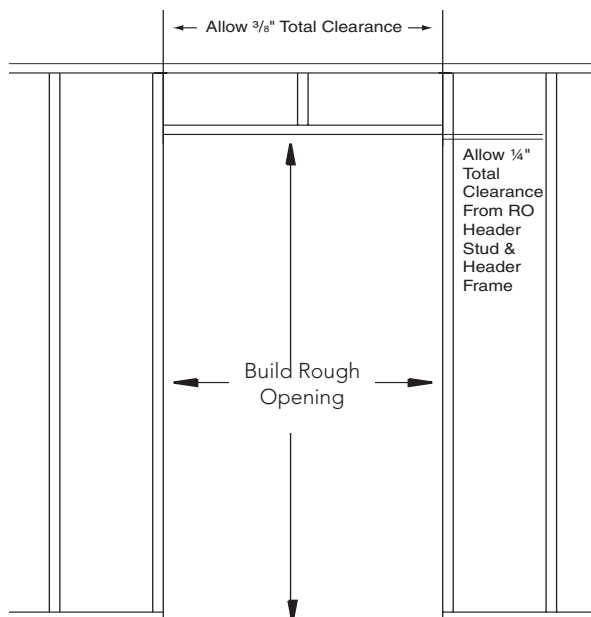

### Step 1-

Build a wood frame around the rough opening allowing 3/8" total clearance between upright studs and frame sides (3/16" clearance per side and 1/4" clearance between frame header and rough opening header stud).

### Step 2-

Check frame opening for plumb and square.

# 2 ATTACH FRAME ANCHORS

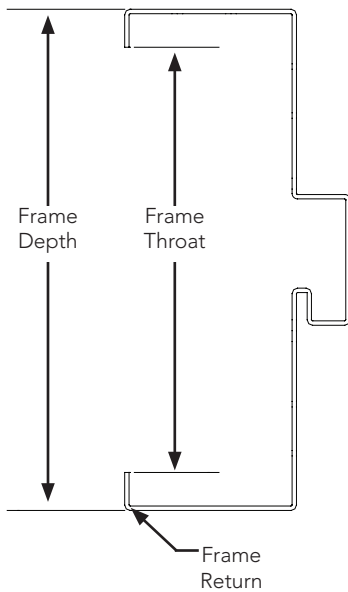
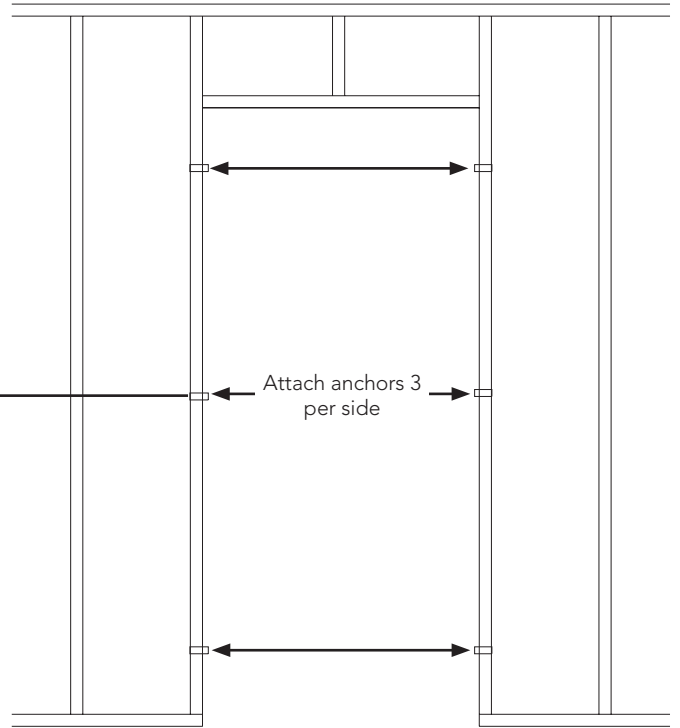
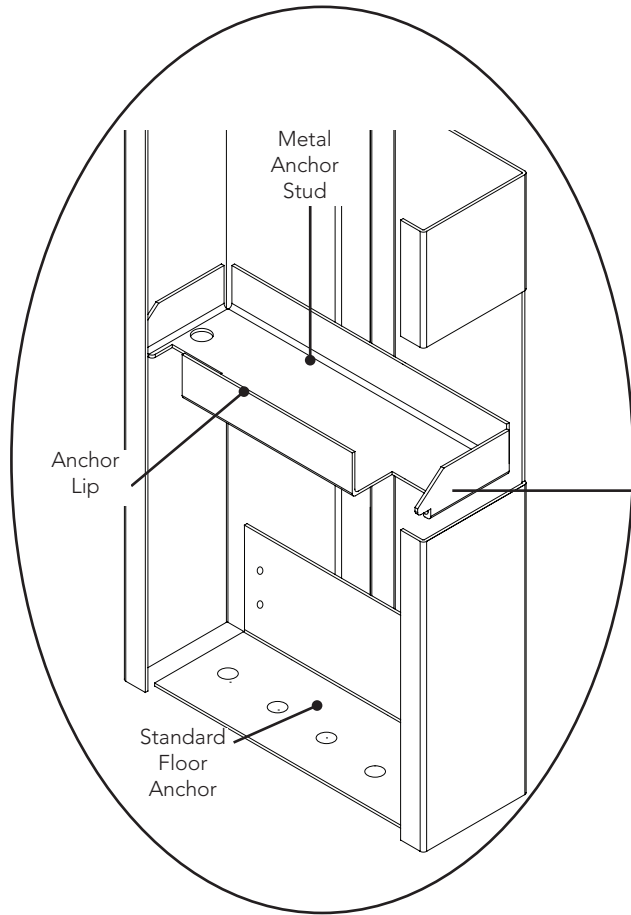

## Step 1-

Insert metal stud anchors into frame throat and tap into place with a hammer.

## Step 2-

Place at hinge location and directly opposite on strike frame. Attach 3 anchors per side, totalling 6 per frame.

# 3 INSTALL FRAME INTO OPENING

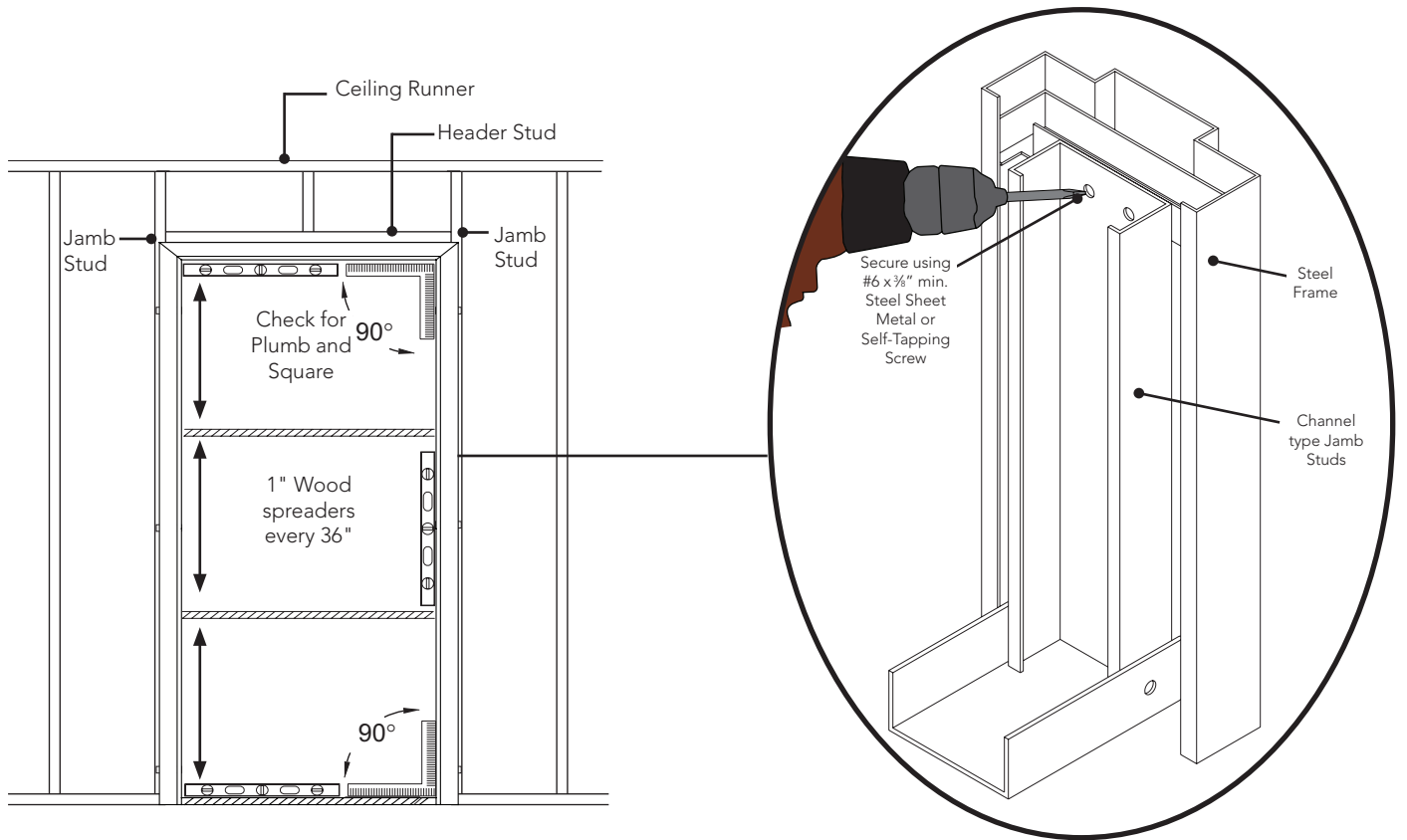

**Step 1-**  
Install 1" wood spreaders every 36" inches as illustrated.

**Step 2-**  
Check for plumb and square.

**Step 3-**  
Attach steel jamb studs to floor through floor anchor or floor extension. Install steel jamb studs to floor and ceiling runners and tightly against frame anchors.

**Step 4-**  
Position steel studs in frame throat and attach to anchors with screws or weld. If using screws, drill from the back side of the stud, through both the stud and anchor, then attach with (2) screws per anchor location (see above illustration).



When attaching header stud to jamb studs, be sure the stud is above frame header. This will assure ample room for attaching plaster lath or drywall and will not interfere with installation of hardware attached to frame header.

**Step 5-**  
Check for plumb and square .

**Step 6-**  
Remove wood spreaders.

# 4

## PREPARE FOR DRYWALL/WALL BOARD



**DO NOT INSTALL** Drywall/Wall Board until you are certain the frame is plumb and square.

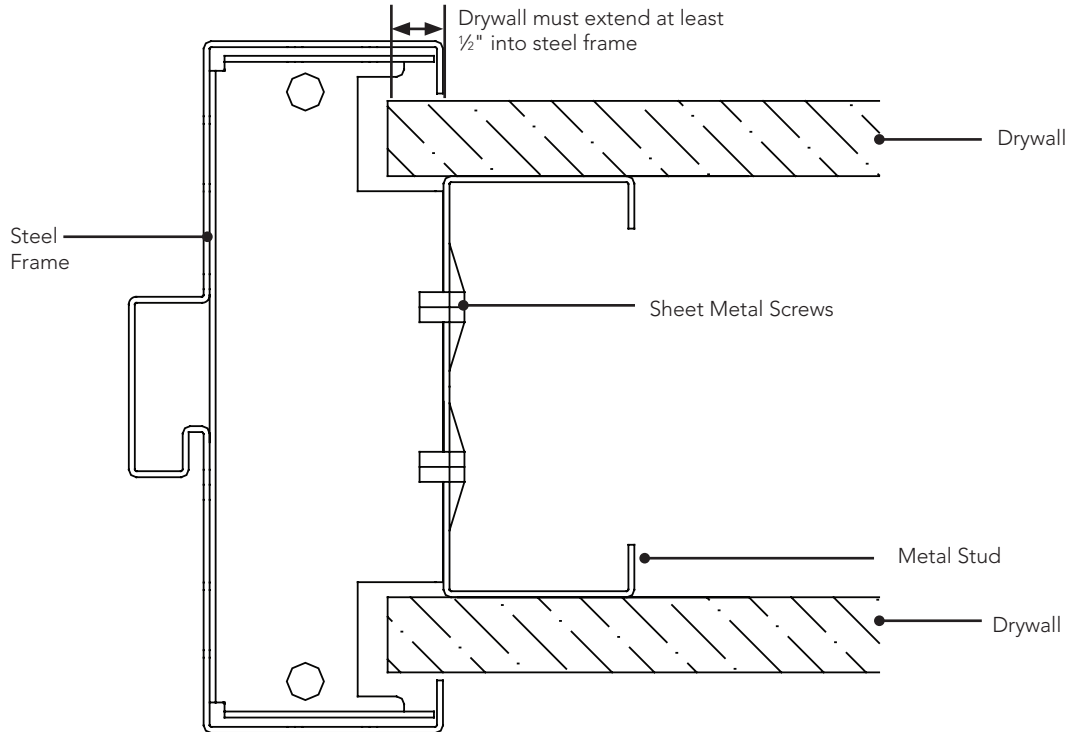

**Note:** Drywall must extend at least 1/2" into frame for Fire Rated Installation.

### Step 1-

Maintain necessary clearance between frame returns and wood stud for inserting drywall/wall board.

### Step 2-

Using drywall screws, install the drywall/wall board.



Contact your local recycling waste management center for waste disposal in your area. Always check local waste requirements and carefully dispose of waste in accordance with Federal and other regulations.

Version 1.4 · 01.14.2022 · © 2022 ProVia · P-MK-61051